

Profile Specification

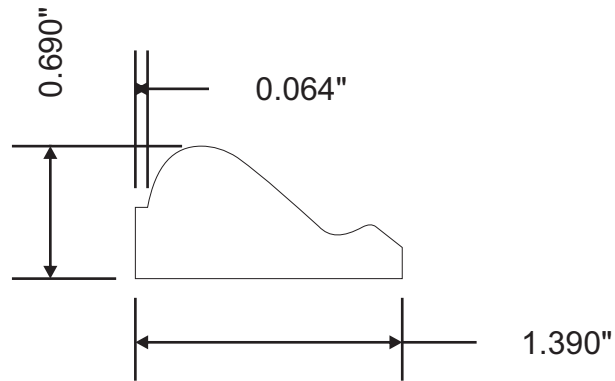

Attention: _____



| Customer | Part # | Specie | Dimensions | Notes |
|----------|-----------|--------|--------------------|-------|
| | MW3-50214 | | 11/16" x 1-3/8" | |
| Revised | | | Approval Signature | |
| | | | | |