

Profile Specification

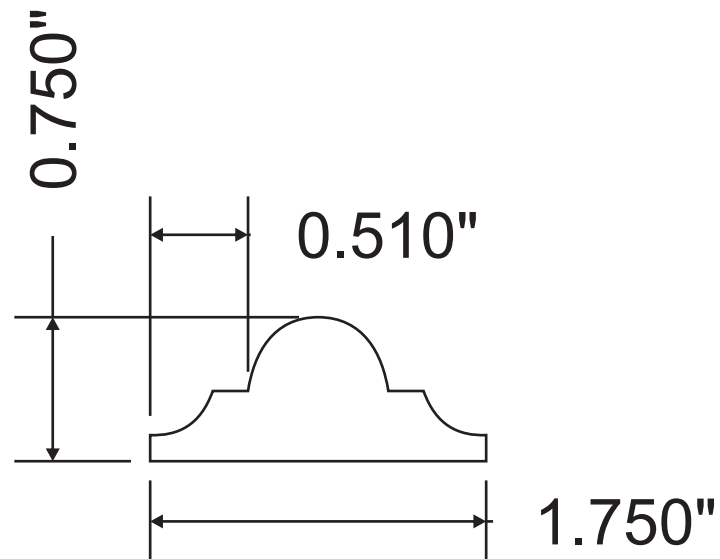

Attention: _____



Customer	Part #	Specie	Dimensions	Notes
	MW3-50198		3/4" x 1-3/4"	
Revised			Approval Signature	