

Profile Specification

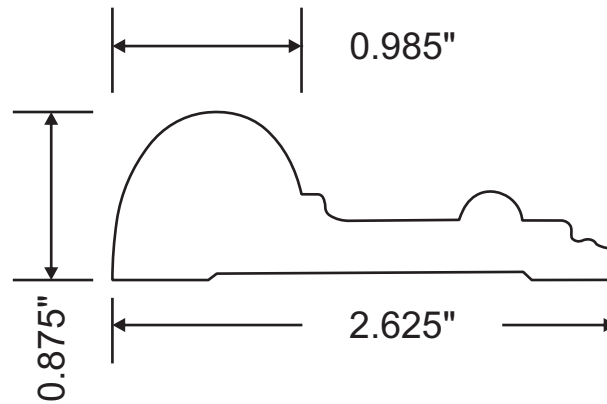

Attention: \_\_\_\_\_



Customer	Part #	Specie	Dimensions	Notes
	MW3-40343		7/8" x 2-5/8"	
Revised			Approval Signature	