

Profile Specification

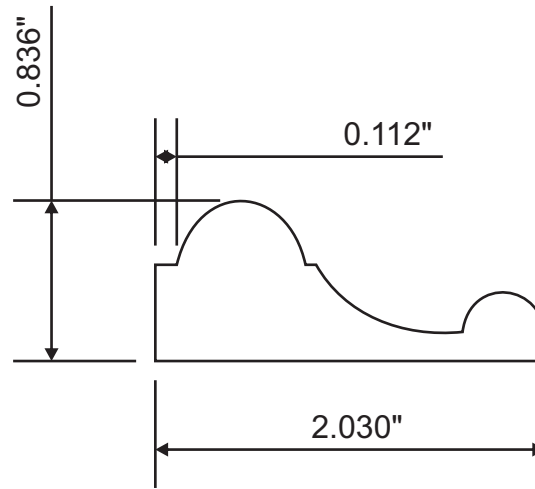

Attention: _____



Customer	Part #	Specie	Dimensions	Notes
	MW3-40256		13/16" x 2-1/16"	
Revised			Approval Signature	