

Profile Specification

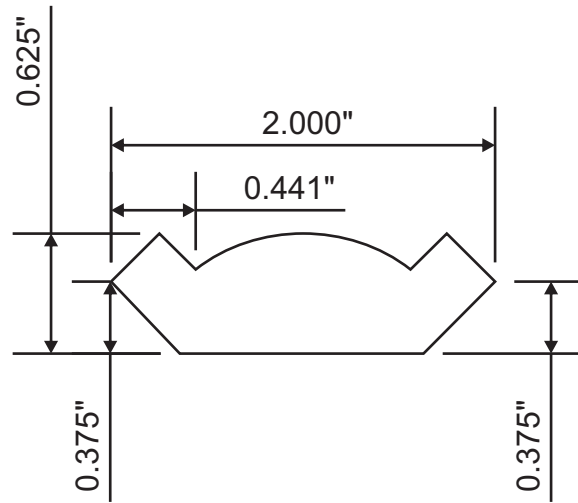

Attention: \_\_\_\_\_



Customer	Part #	Specie	Dimensions	Notes
	MW3-30109		5/8" x 2"	
Revised			Approval Signature	