

Profile Specification

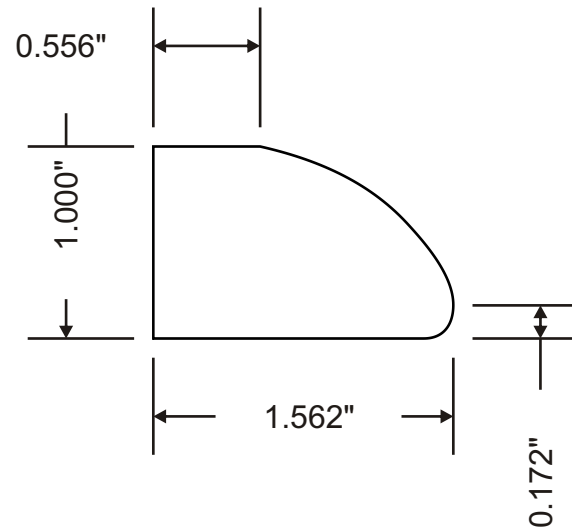

Attention: _____



Customer	Part #	Specie	Dimensions	Notes
	MW3-7481		1" x 1-9/16"	
Revised			Approval Signature	