

Profile Specification

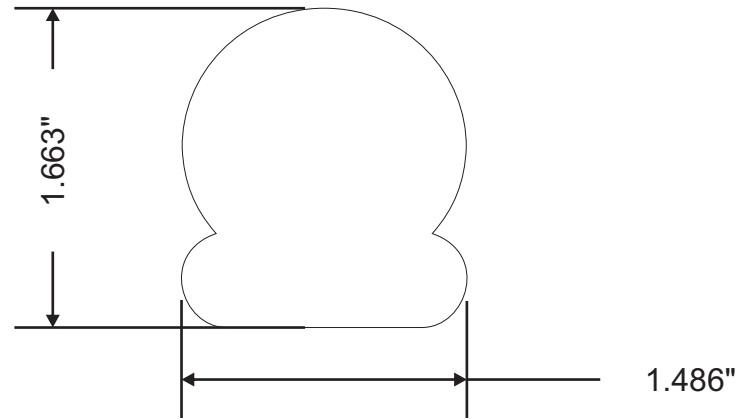

Attention: \_\_\_\_\_



Customer	Part #	Specie	Dimensions	Notes
	MW3-6013		1-5/8" x 1-1/2"	
Revised			Approval Signature	