

Profile Specification

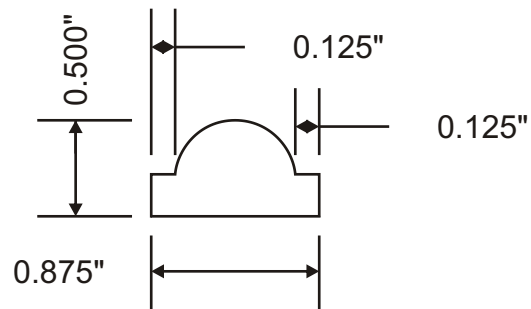

Attention: \_\_\_\_\_



Customer	Part #	Specie	Dimensions	Notes
	MW3-50919		1/2" x 7/8"	
Revised			Approval Signature	