

Profile Specification

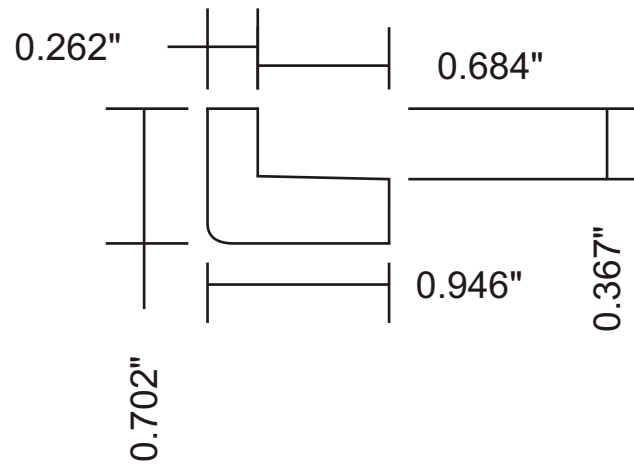

Attention: _____



Customer	Part #	Specie	Dimensions	Notes
	MW3-50888		11/16" x 15/16"	
Revised			Approval Signature	