

Profile Specification

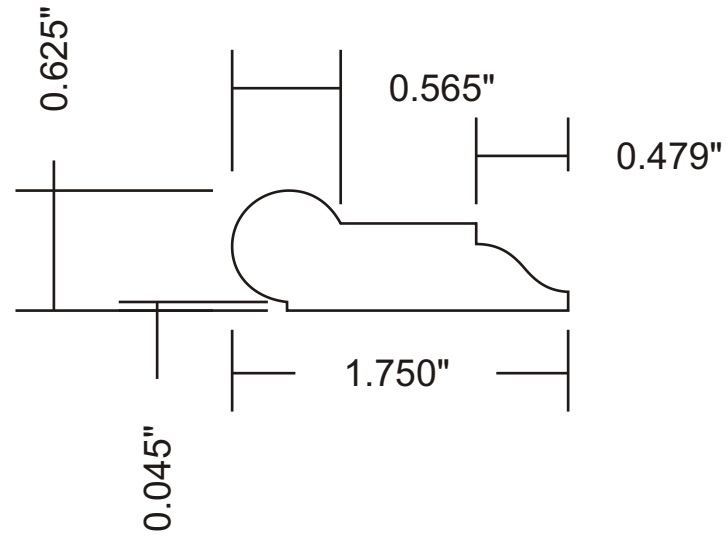

Attention: \_\_\_\_\_



Customer	Part #	Specie	Dimensions	Notes
	MW3-50878		5/8" x 1-3/4"	
Revised			Approval Signature	