

Profile Specification

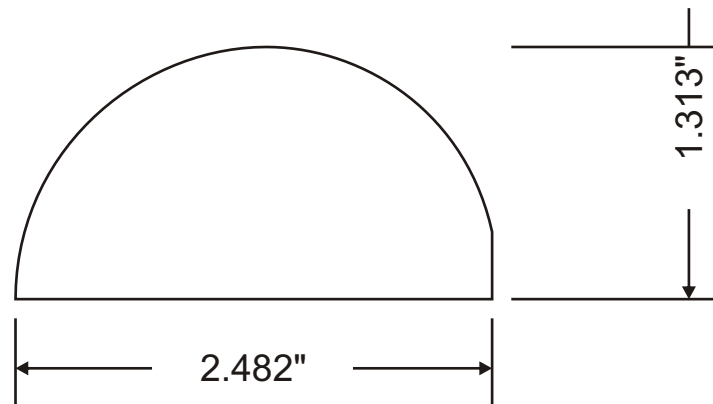

Attention: \_\_\_\_\_



Customer	Part #	Specie	Dimensions	Notes
	MW3-50834		1-5/16" x 2-1/2"	
Revised			Approval Signature	