

Profile Specification

MILLWORK 360

THE DEGREE OF SUPERIOR QUALITY

Attention: _____

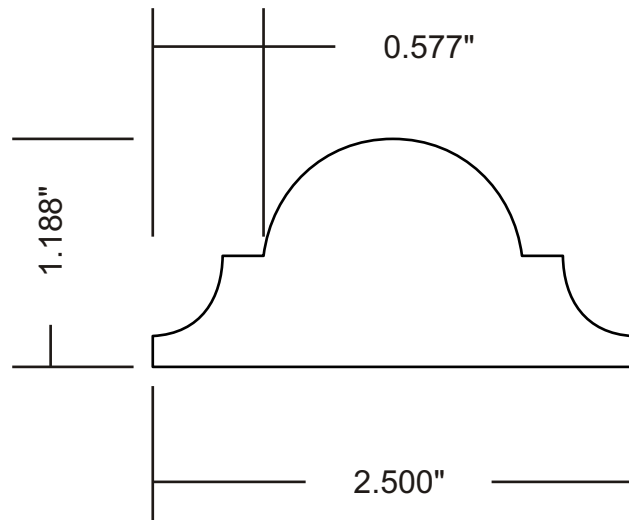

Customer	Part #	Specie	Dimensions	Notes
	MW3-50780		1-3/16" x 2-1/2"	
Revised			Approval Signature	