

Profile Specification

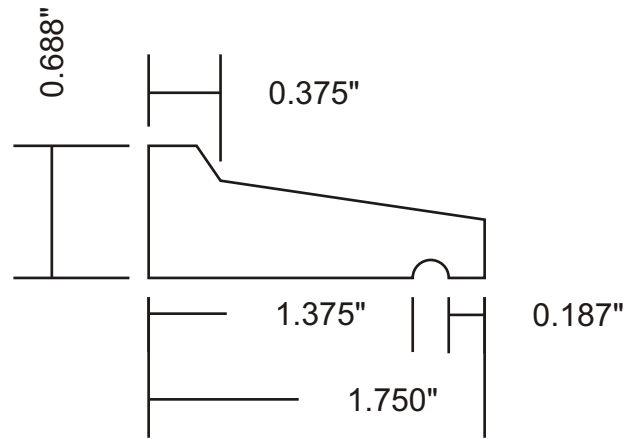

Attention: _____



Customer	Part #	Specie	Dimensions	Notes
	MW3-50728		11/16" x 1-3/4"	
Revised			Approval Signature	