

Profile Specification

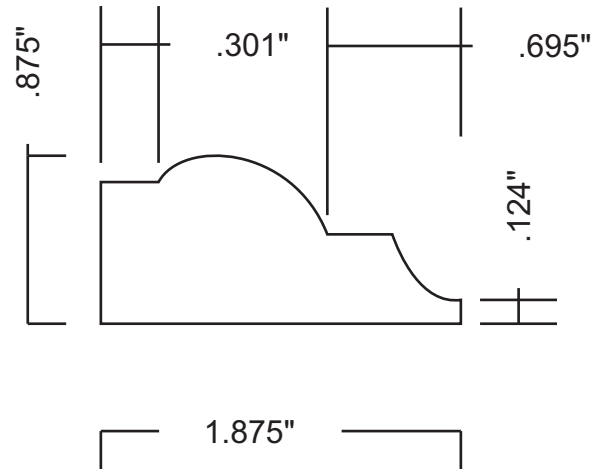

Attention: _____



Customer	Part #	Specie	Dimensions	Notes
	MW3-50345		7/8" x 1-7/8"	
Revised			Approval Signature	