

Profile Specification

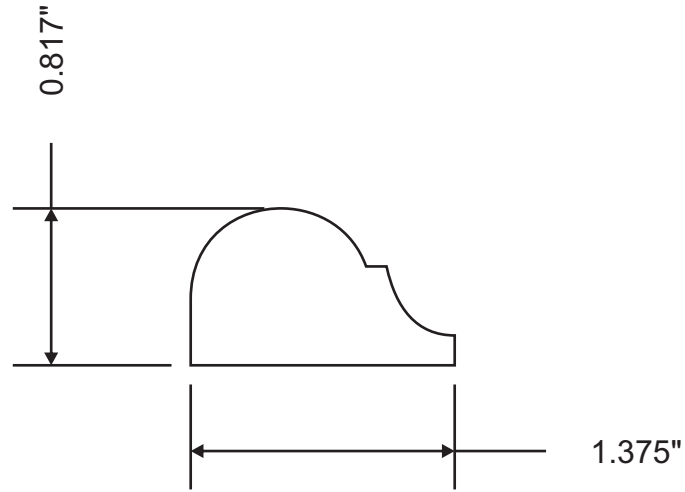

Attention: _____



Customer	Part #	Specie	Dimensions	Notes
	MW3-50219		13/16" x 1-3/8"	
Revised			Approval Signature	