

Profile Specification

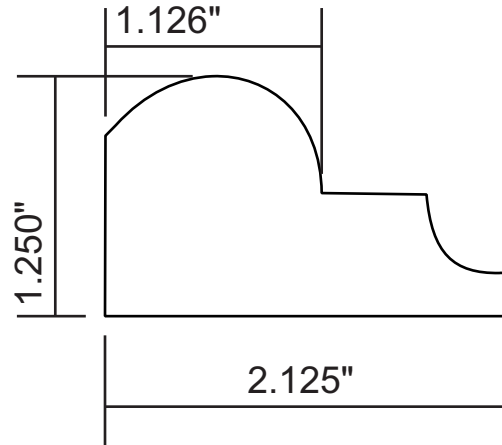

Attention: \_\_\_\_\_



Customer	Part #	Specie	Dimensions	Notes
	MW3-50154		1-1/4" x 2-1/8"	
Revised			Approval Signature	