

Profile Specification

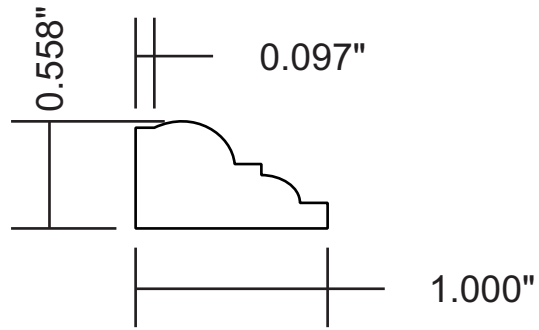

Attention: _____



Customer	Part #	Specie	Dimensions	Notes
	MW3-50147		9/16" x 1"	
Revised			Approval Signature	