

Profile Specification

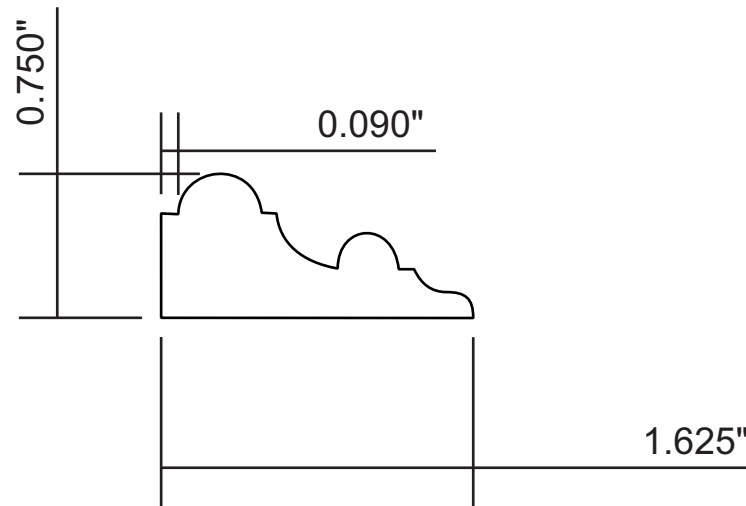

Attention: \_\_\_\_\_



Customer	Part #	Specie	Dimensions	Notes
	MW3-50104		3/4" x 1-5/8"	
Revised			Approval Signature	