

Profile Specification

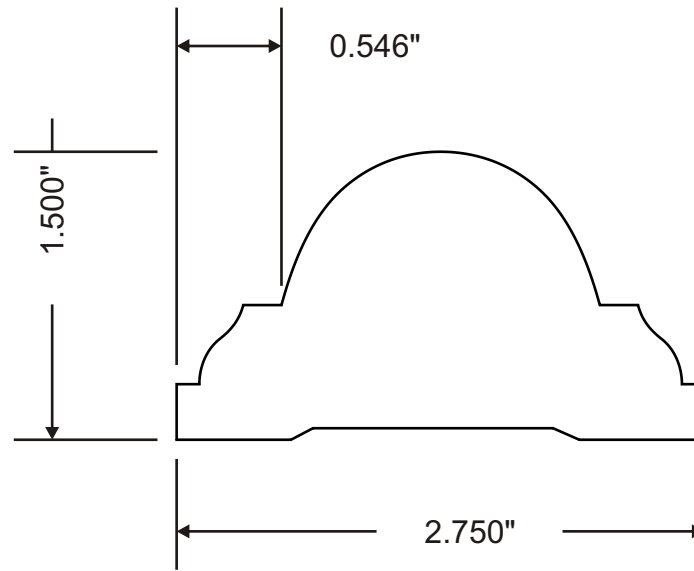

Attention: \_\_\_\_\_



Customer	Part #	Specie	Dimensions	Notes
	MW3-40476		1-1/2" x 2-3/4"	
Revised			Approval Signature	