

Profile Specification

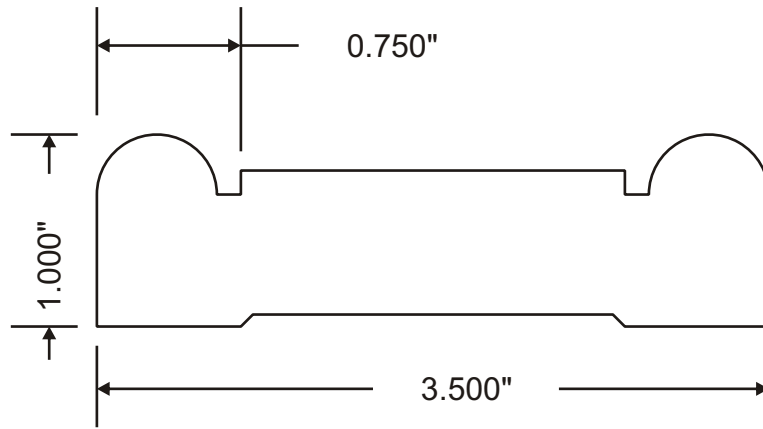

Attention: \_\_\_\_\_



Customer	Part #	Specie	Dimensions	Notes
	MW3-40472		1" x 3-1/2"	
Revised			Approval Signature	