

Profile Specification

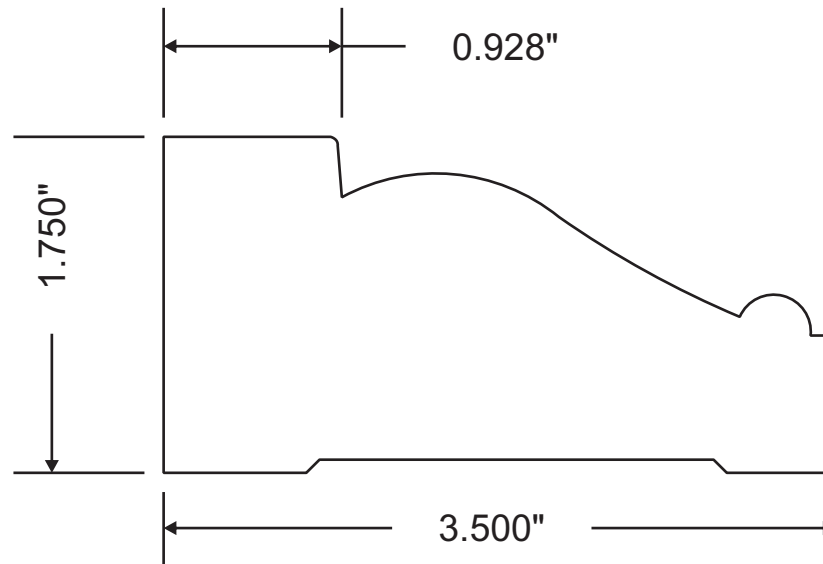

Attention: _____



Customer	Part #	Specie	Dimensions	Notes
	MW3-40346		1-3/4" x 3-1/2"	
Revised			Approval Signature	