

Profile Specification

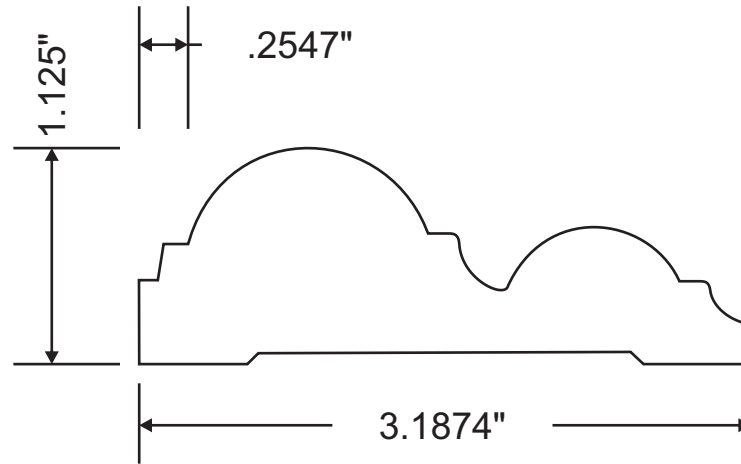

Attention: _____



Customer	Part #	Specie	Dimensions	Notes
	MW3-40290		1-1/8" x 3-3/16"	
Revised			Approval Signature	