

Profile Specification

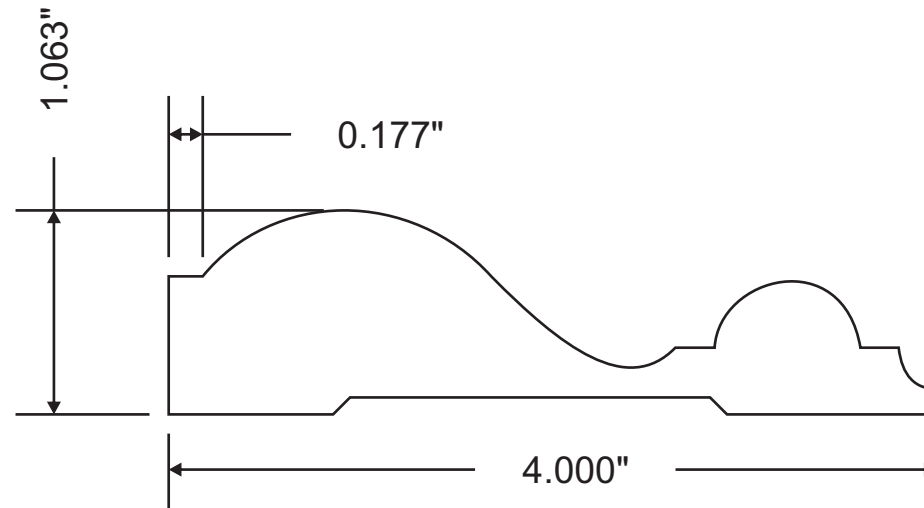

Attention: _____



Customer	Part #	Specie	Dimensions	Notes
	MW3-40280		1-1/16" x 4"	
Revised			Approval Signature	