

Profile Specification

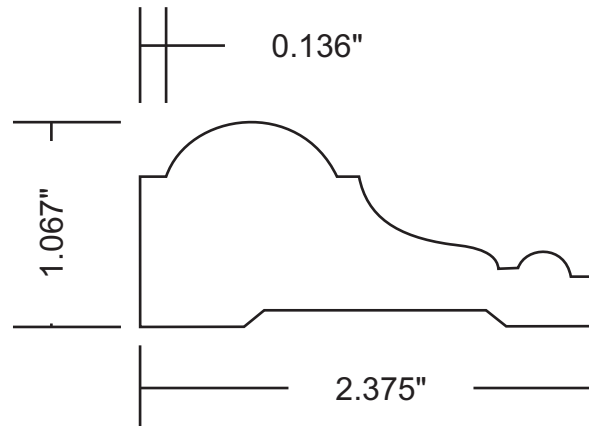

Attention: _____



Customer	Part #	Specie	Dimensions	Notes
	MW3-40016		1-1/16" x 2-3/8"	
Revised			Approval Signature	