

Profile Specification

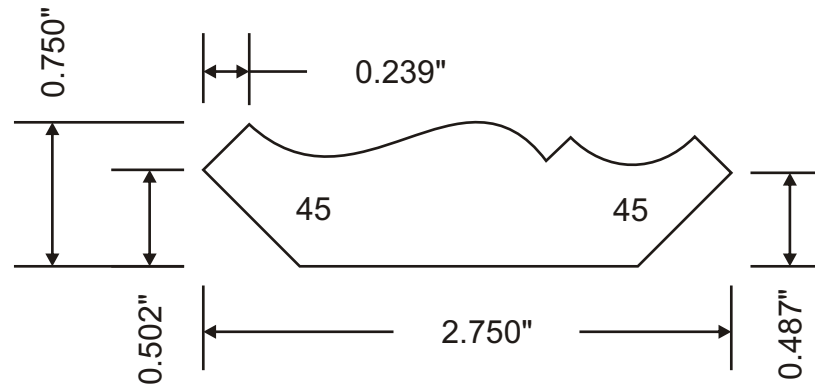

Attention: \_\_\_\_\_



Customer	Part #	Specie	Dimensions	Notes
	MW3-30780		3/4" x 2-3/4"	
Revised			Approval Signature	