

Profile Specification

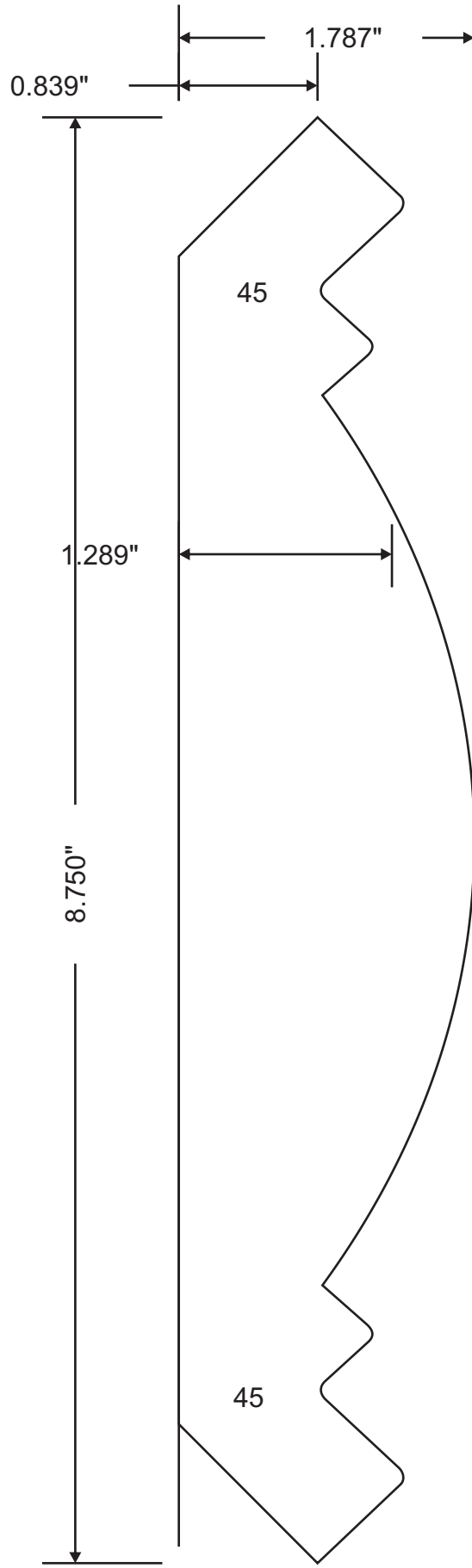

Attention: \_\_\_\_\_



Customer	Part #	Specie	Dimensions	Notes
	MW3-30577		1-3/4" x 8-3/4"	
Revised			Approval Signature	