

Profile Specification

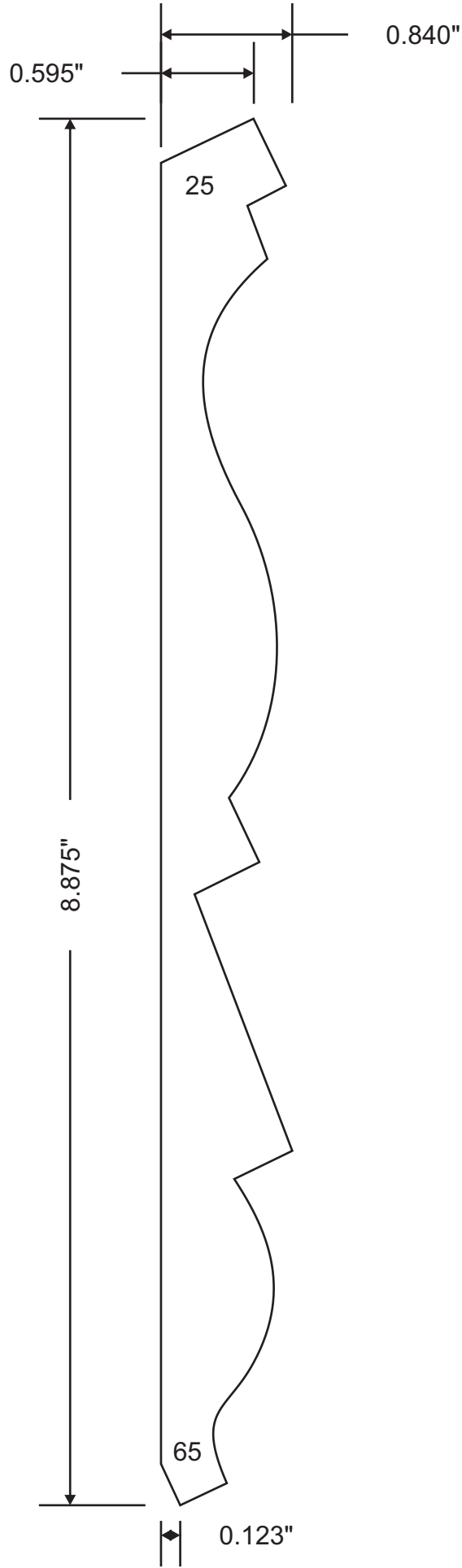

Attention: _____



Customer	Part #	Specie	Dimensions	Notes
	MW3-30575		7/8" x 8-7/8"	
Revised			Approval Signature	