

Profile Specification

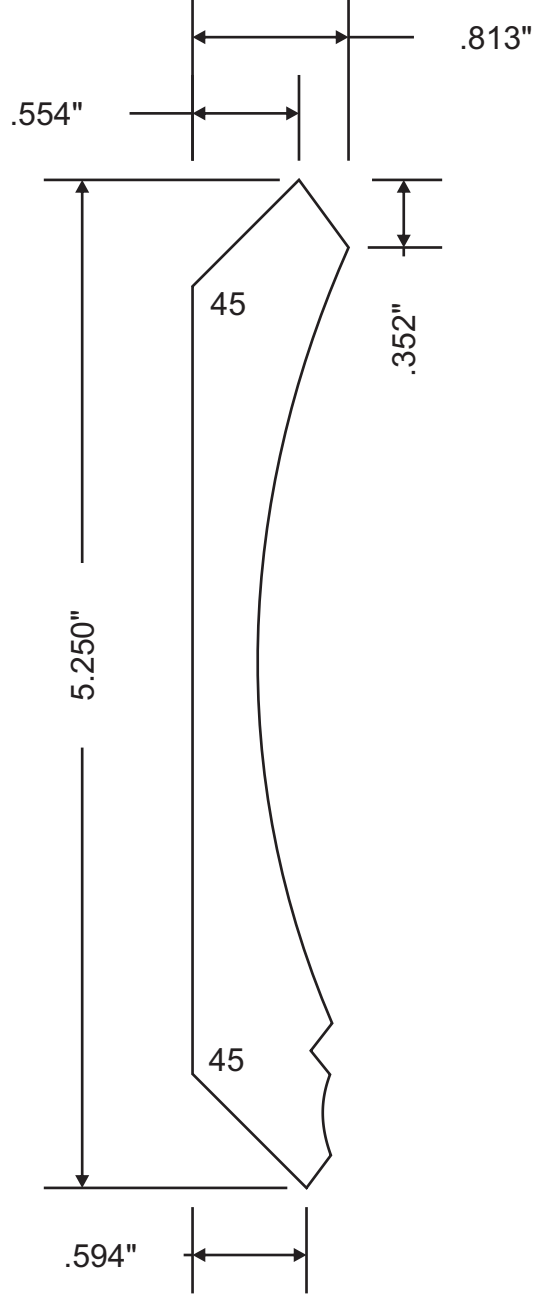

Attention: \_\_\_\_\_



Customer	Part #	Specie	Dimensions	Notes
	MW3-30569		13/16" x 5-1/4"	
Revised			Approval Signature	