

Profile Specification

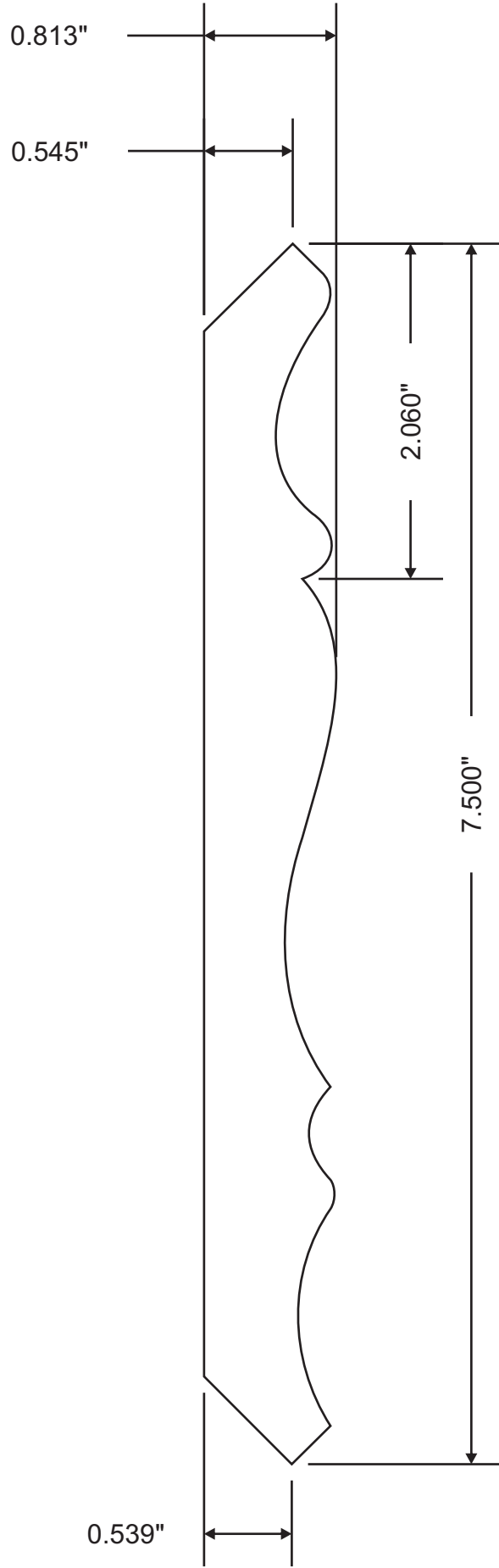

Attention: _____



Customer	Part #	Specie	Dimensions	Notes
	MW3-30350		13/16" x 7-1/2"	
Revised			Approval Signature	