

Profile Specification

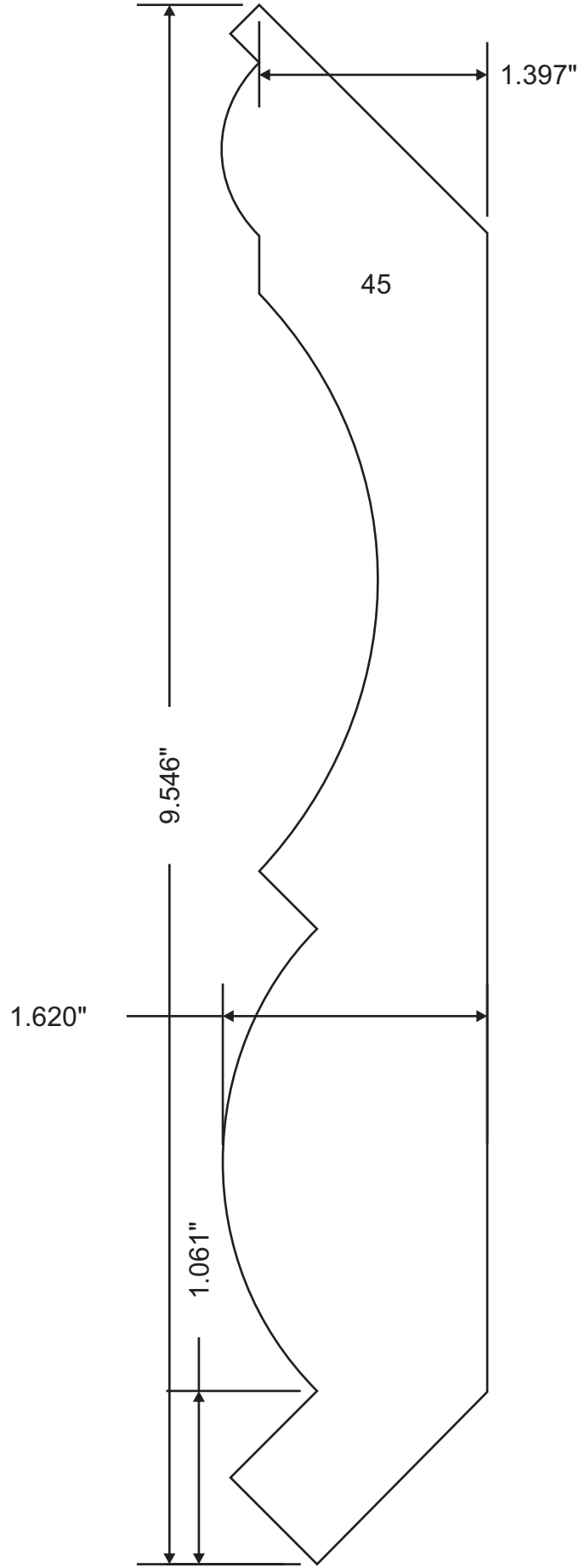

Attention: \_\_\_\_\_



Customer	Part #	Specie	Dimensions	Notes
	MW3-30299		1-5/8" x 9-9/16"	
Revised			Approval Signature	