

Profile Specification

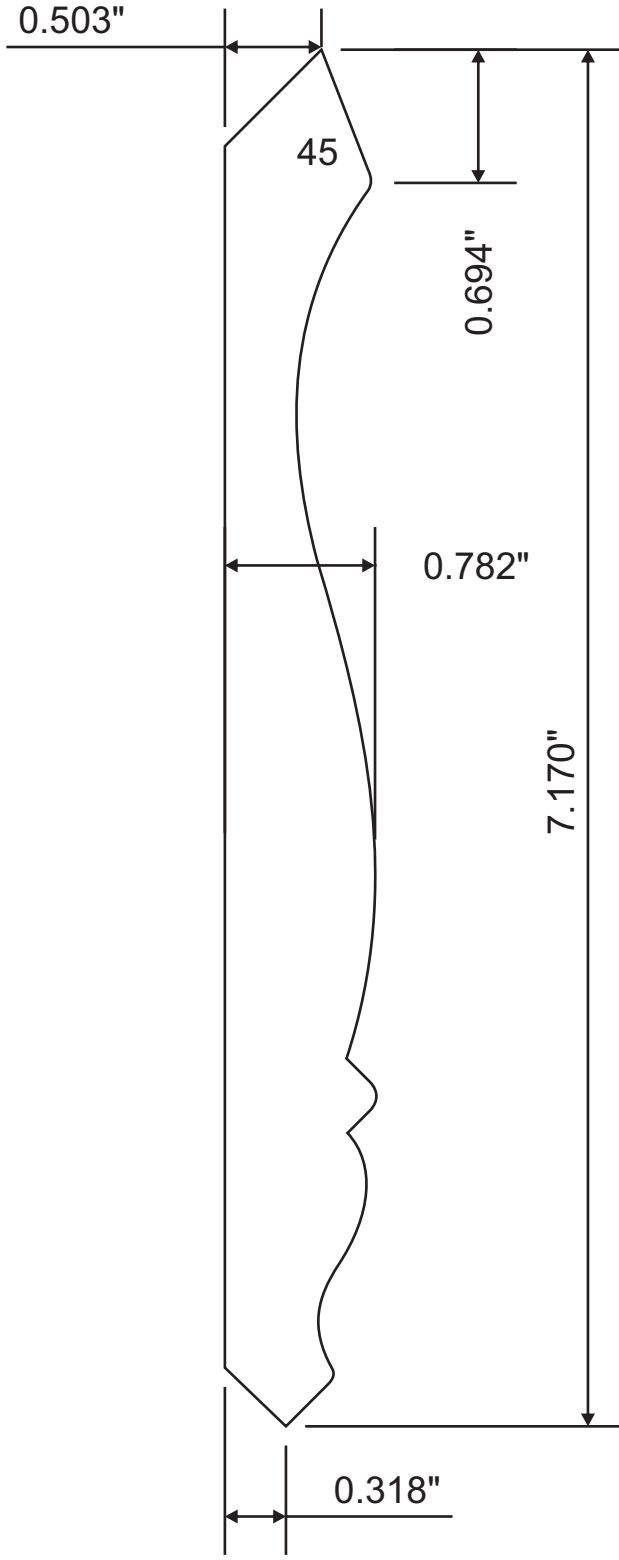

Attention: _____



Customer	Part #	Specie	Dimensions	Notes
	MW3-30282		3/4" x 7-3/16"	
Revised			Approval Signature	