

Profile Specification

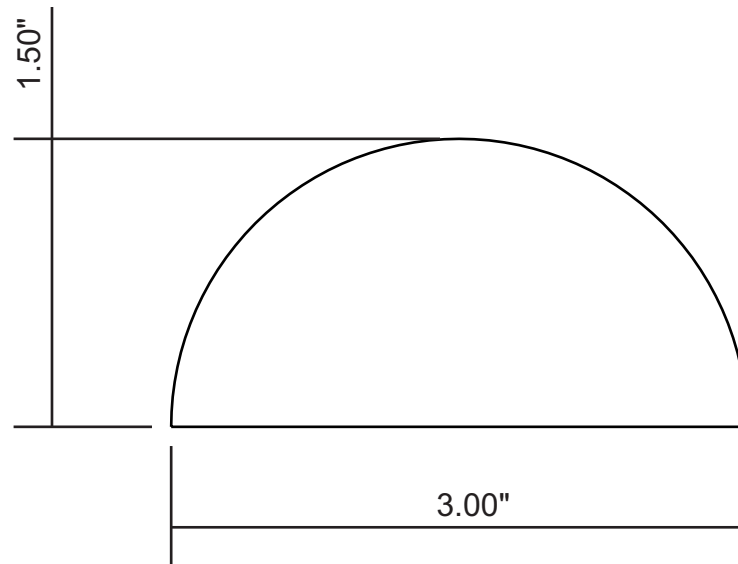

Attention: _____



Customer	Part #	Specie	Dimensions	Notes
	MW3-3005		1-1/2" x 3"	
Revised			Approval Signature	