

Profile Specification

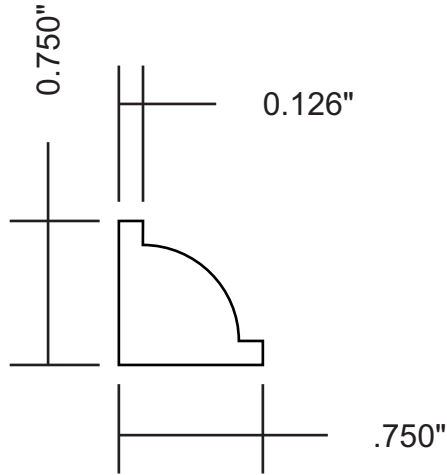

Attention: \_\_\_\_\_



Customer	Part #	Specie	Dimensions	Notes
	MW3-2209		3/4" x 3/4"	
Revised			Approval Signature	