

Profile Specification

MILLWORK 360

THE DEGREE OF SUPERIOR QUALITY

Attention: _____

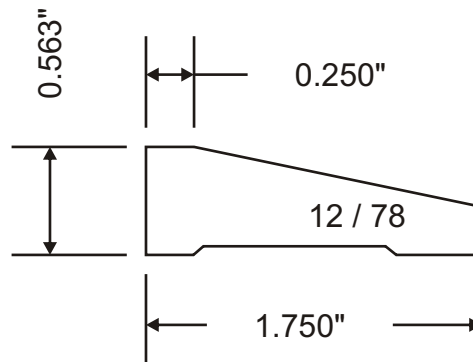

Customer	Part #	Specie	Dimensions	Notes
	MW3-20953		9/16" x 1-3/4"	
Revised			Approval Signature	