

Profile Specification

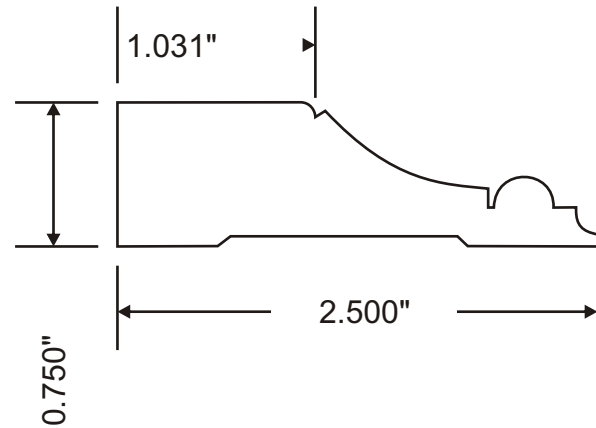

Attention: \_\_\_\_\_



Customer	Part #	Specie	Dimensions	Notes
	MW3-20942		3/4" x 2-1/2"	
Revised			Approval Signature	