

Profile Specification

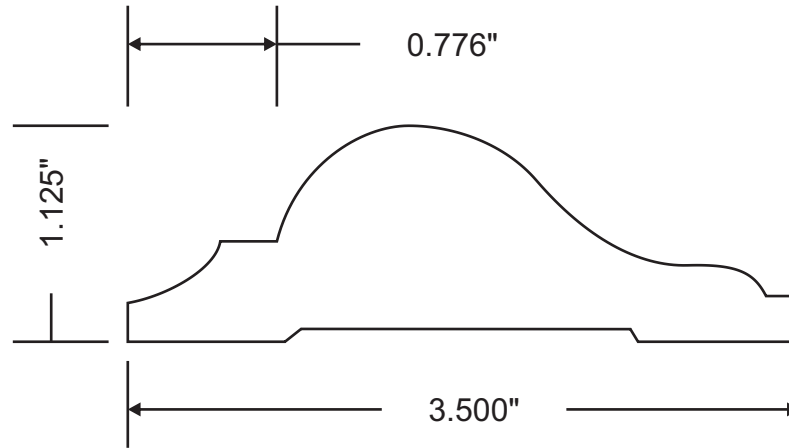

Attention: \_\_\_\_\_



Customer	Part #	Specie	Dimensions	Notes
	MW3-20760		1-1/8"x3-1/2"	
Revised			Approval Signature	