

Profile Specification

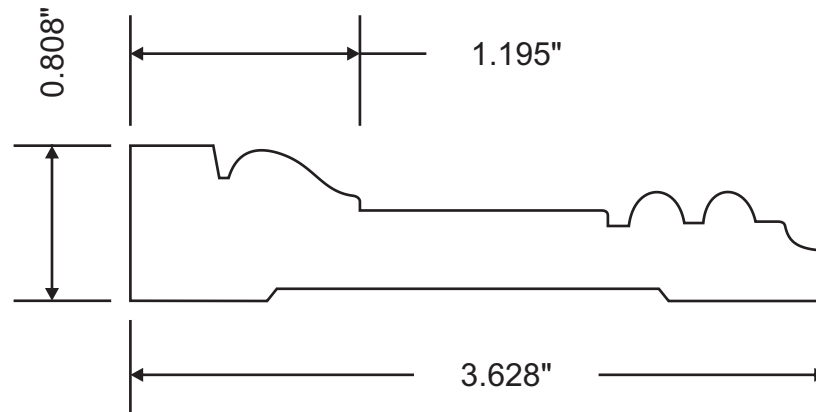

Attention: _____



Customer	Part #	Specie	Dimensions	Notes
	MW3-20673		3/4"x3-5/8"	
Revised			Approval Signature	