

Profile Specification

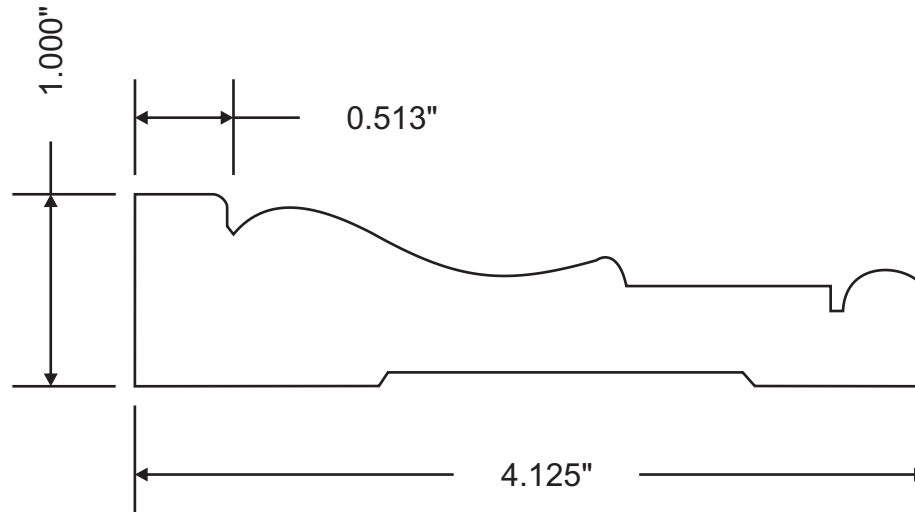

Attention: _____



Customer	Part #	Specie	Dimensions	Notes
	MW3-20614		1" x 4-1/8"	
Revised			Approval Signature	