

Profile Specification

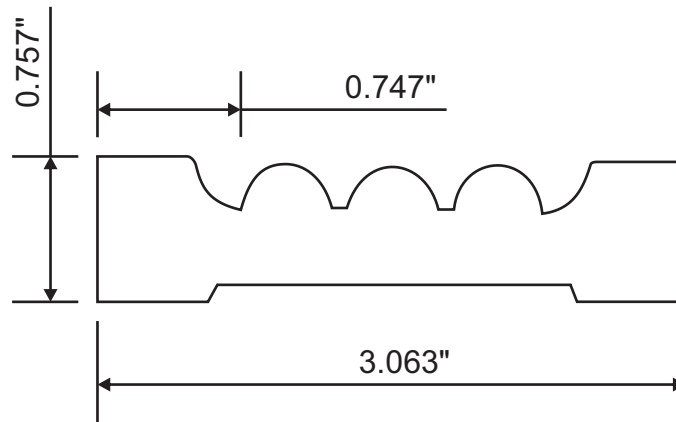

Attention: _____



| Customer | Part # | Specie | Dimensions | Notes |
|----------|-----------|--------|--------------------|-------|
| | MW3-20607 | | 3/4" x 3-1/16" | |
| Revised | | | Approval Signature | |
| | | | | |