

Profile Specification

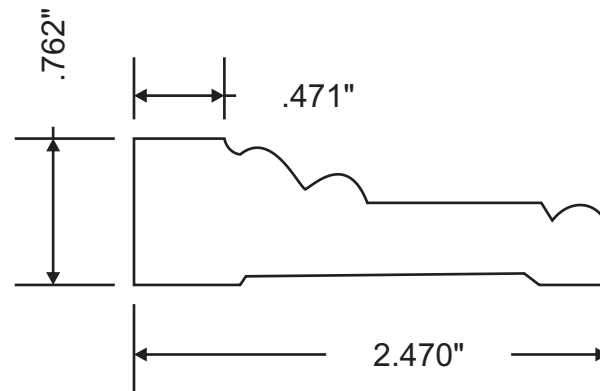

Attention: _____



| Customer | Part # | Specie | Dimensions | Notes |
|----------|-----------|--------|--------------------|-------|
| | MW3-20584 | | 3/4" x 2-1/2" | |
| Revised | | | Approval Signature | |
| | | | | |