

Profile Specification

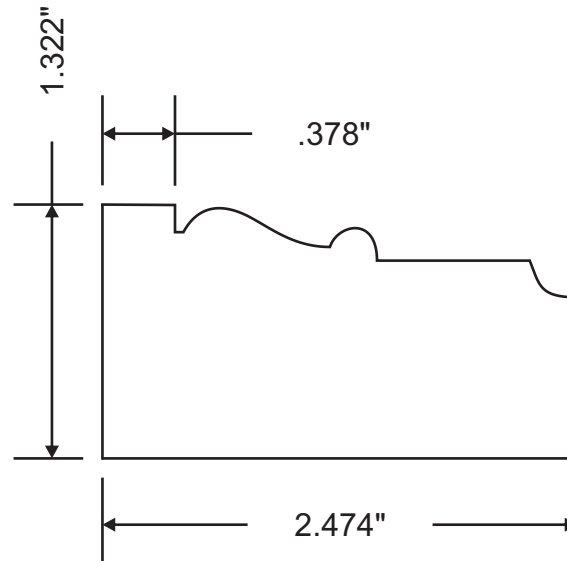

Attention: _____



Customer	Part #	Specie	Dimensions	Notes
	MW3-20583		1-5/16" x 2-1/2"	
Revised			Approval Signature	