

Profile Specification

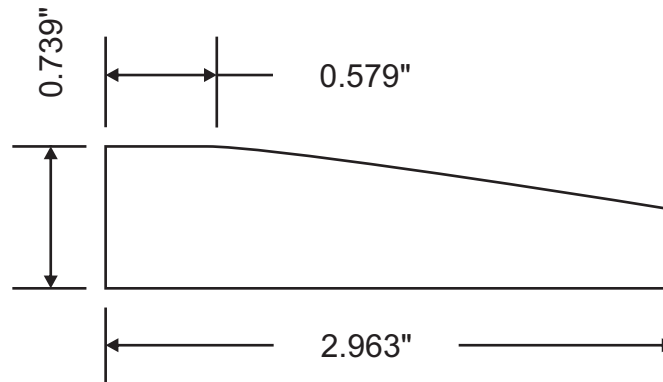

Attention: \_\_\_\_\_



Customer	Part #	Specie	Dimensions	Notes
	MW3-20498		3/4" x 3"	
Revised			Approval Signature	