

Profile Specification

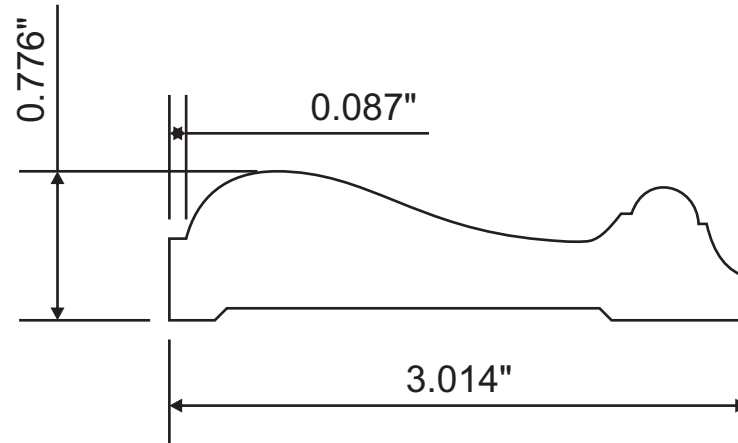

Attention: _____



Customer	Part #	Specie	Dimensions	Notes
	MW3-20404		3/4" x 5"	
Revised			Approval Signature	