

Profile Specification

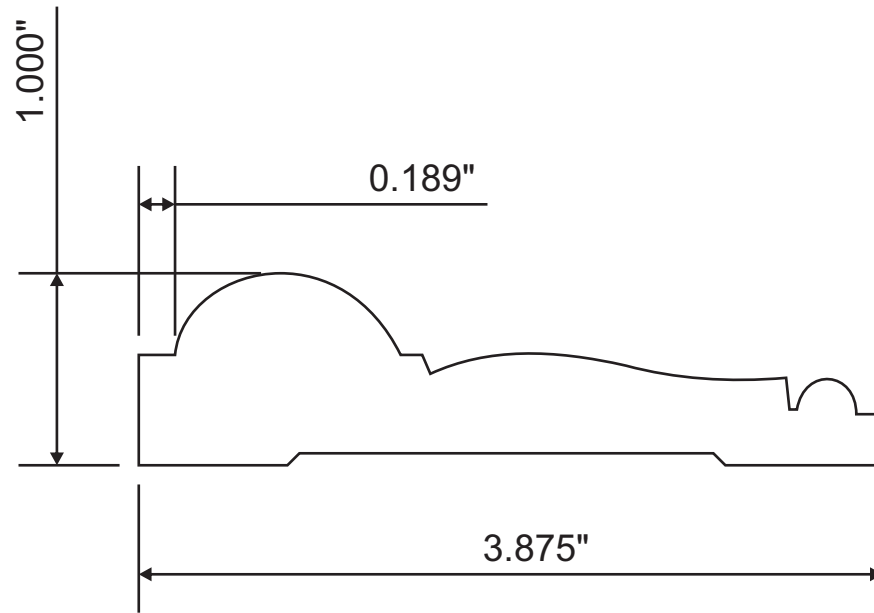

Attention: \_\_\_\_\_



Customer	Part #	Specie	Dimensions	Notes
	MW3-20394		1" x 3-7/8"	
Revised			Approval Signature	