

Profile Specification

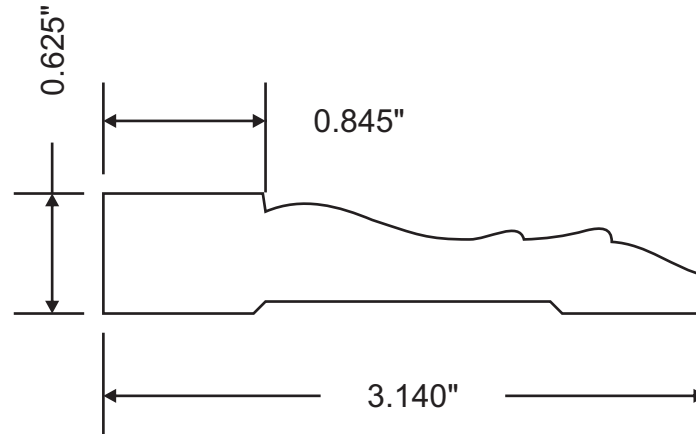

Attention: \_\_\_\_\_



Customer	Part #	Specie	Dimensions	Notes
	MW3-20318		5/8" x 3-1/8"	
Revised			Approval Signature	