

Profile Specification

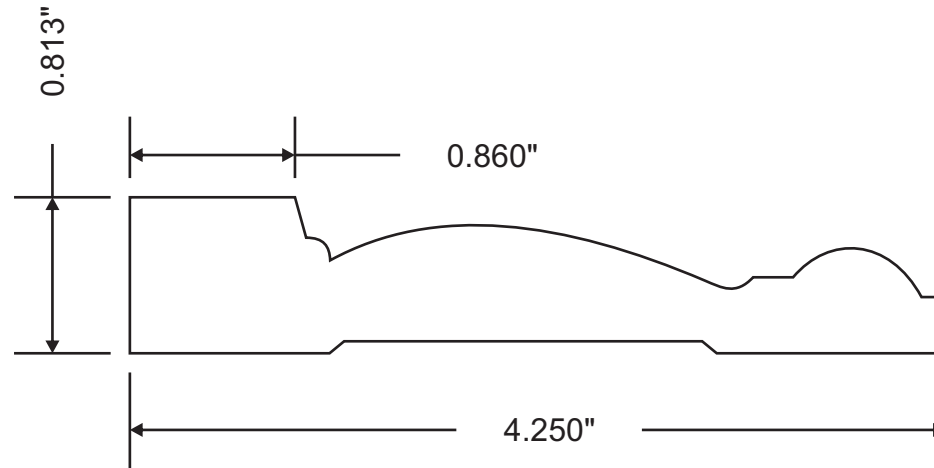

Attention: \_\_\_\_\_



Customer	Part #	Specie	Dimensions	Notes
	MW3-20311		13/16" x 4-1/4"	
Revised			Approval Signature	