

Profile Specification

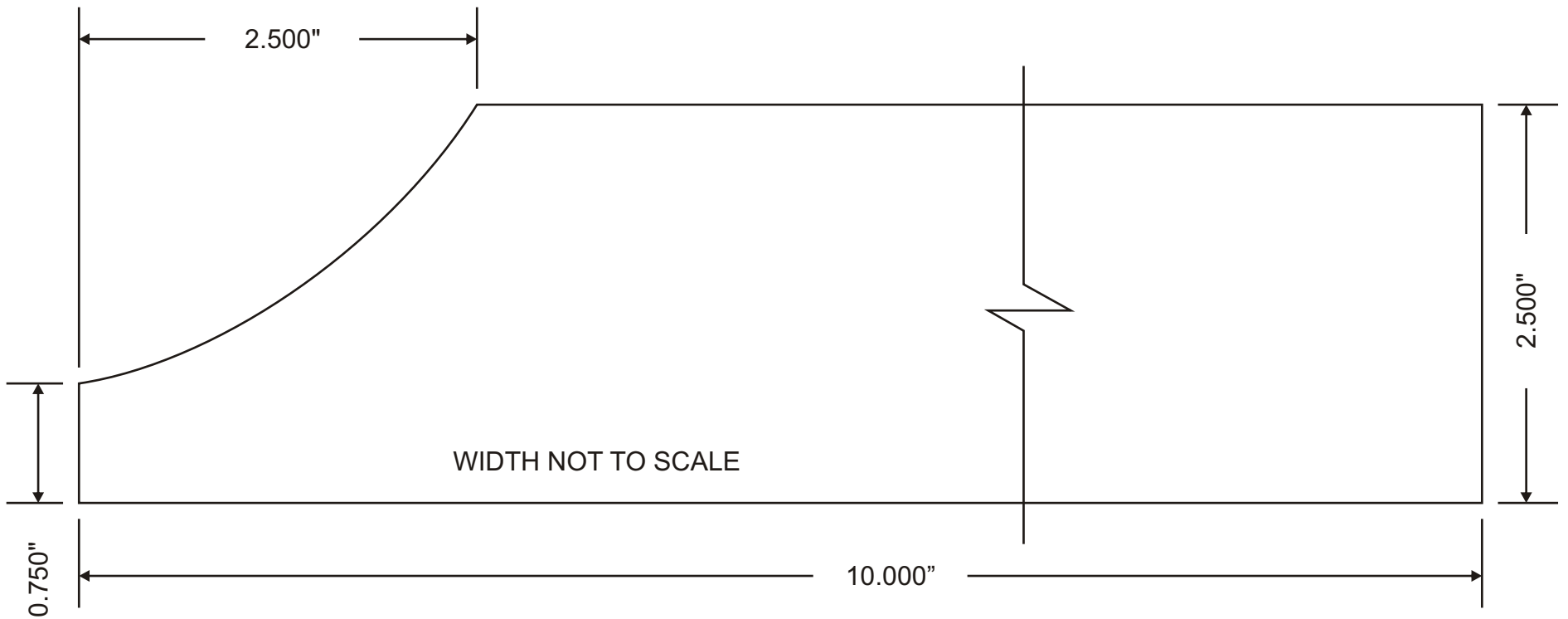

Attention: _____



Customer	Part #	Specie	Dimensions	Notes
	MW3-2030		2-1/2" x 10"	
Revised			Approval Signature	