

Profile Specification

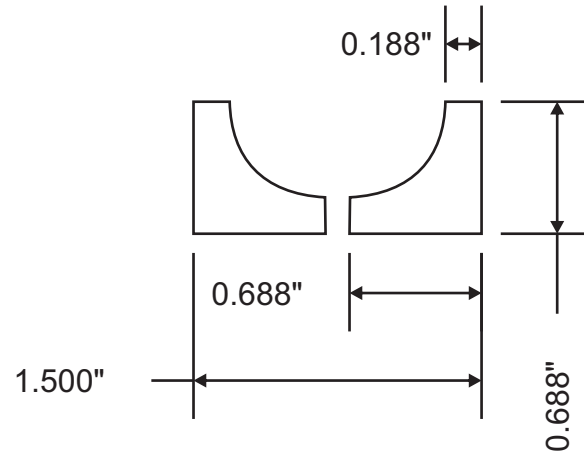

Attention: \_\_\_\_\_



Customer	Part #	Specie	Dimensions	Notes
	MW3-2009		11/16" x 11/16"	
Revised			Approval Signature	