

Profile Specification

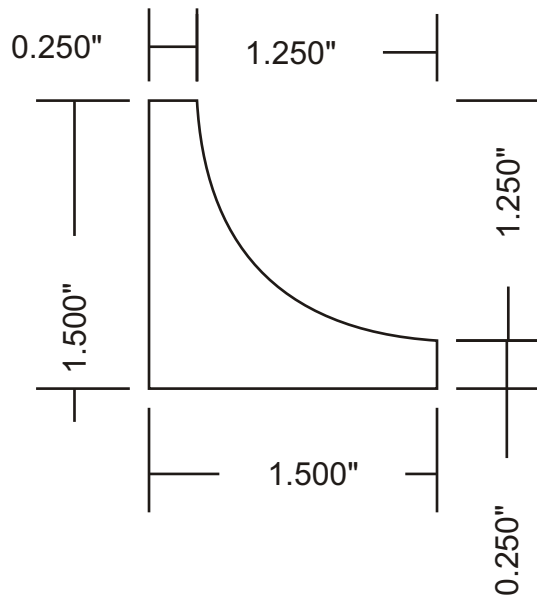

Attention: \_\_\_\_\_



Customer	Part #	Specie	Dimensions	Notes
	MW3-2003		1-1/2" x 1-1/2"	
Revised			Approval Signature	