

Profile Specification

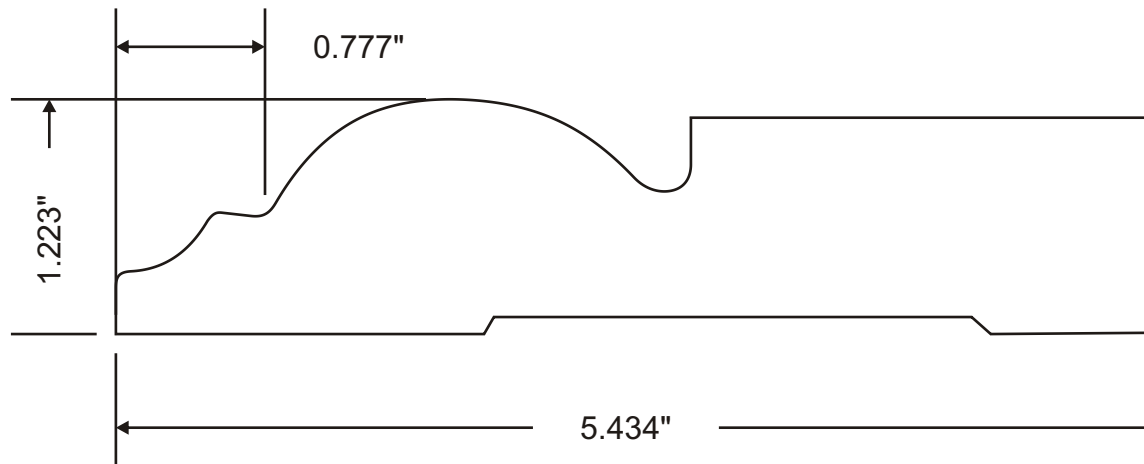

Attention: _____



Customer	Part #	Specie	Dimensions	Notes
	MW3-11099		1-1/4" x 5-7/16"	
Revised			Approval Signature	